



Pole Assembly

For 25m Seesaw Pole HPM25F

The purpose of this technical instruction is to detail those on site actions necessary to ensure the correct assembly of the 25 metre high (HPM25F) Seesaw column. This technical instruction must be read in conjunction with 8.6.02 Pole Assembly and Installation for Floodlight Poles.

1.0 Instruction Details

1.1 With reference to the attached drawing on Page 2 (figure 1), the assembly procedure is as follows:

Columns will be delivered in five separate sections joined as follows:

1. PK23CS joined to PK3.
2. PK5H.
3. PK6Q joined to PK734FDN.
4. Apron PK30AA.
5. Apron PK30AB.

Required assembly on site as follows:

1. Section PK5H is required to be joined to section PK6Q (refer to 8.6.02 Pole Assembly and Installation for Floodlight Poles).
2. Section PK3 is required to be joined to section PK30AA (refer to 8.6.02 Pole Assembly and Installation for Floodlight Poles).
3. Apron sections PK30AA and PK30AB are required to be bolted together by means of 20 number 5/8" UNC Socket Button Head Screws, supplied, (the nut, one flat washer and spring washer are to be located on the outside face of the apron). The apron sections are match marked – ensure the correct apron parts are joined together.
4. The apron can then be married up to the main column section to enable the two 18mm diameter holes, at 300mm centres for the balance weight, to be drilled to coincide with the balance weight recess.

The balance weight is then required to be attached to the inside of the apron section by means of the supplied bolts.

Note: Some poles will not require a balance weight. On the same project with multiple poles, the balance weight may vary in each pole according to the actual top load specified – ensure the pole with the correct balance is used for each arrangement (if in doubt, contact INGAL EPS).

5. Three holes are required to be drilled diameter 13.5mm and tapped 5/8" UNC in the PK734FDN section 592mm ± 125mm above the top of the base plate to coincide with the slots in the apron. The apron can then be secured to the main shaft by means of the apron securing Socket Button Head Screws provided.

1.2 After assembly of the column and whilst the column is on the ground, attach all fittings to the top of the column; headframe, crossarms, luminaires, lighting arrestors...etc.

Note: Headframes and crossarms should be attached to the chain link at the top of the column, via the chain and "D" shackle provided, as a safety precaution should the headframe or crossarm work loose.

1.3 Columns are supplied with a balance weight to counteract the weight of the top fittings, so prior to standing the column **all fittings must be attached** for the Seesaw system to function effectively.

Note: 1. Some Seesaw columns do not require a balance weight, as the weight of the apron only is sufficient to counter balance the top weight.

2. Attachments (eg. luminaires, crossarms, banners etc.) **must not** be changed/modified from the original specification at time of order unless consultation has been sought from INGAL EPS. Failure to consult INGAL EPS prior to changes may result in damage to property or serious injury and will void INGAL EPS' liability.

1.4 Ensure that there is sufficient slackness in the electrical cables running up the inside of the column to allow for lowering of the column and that the



Figure 1.

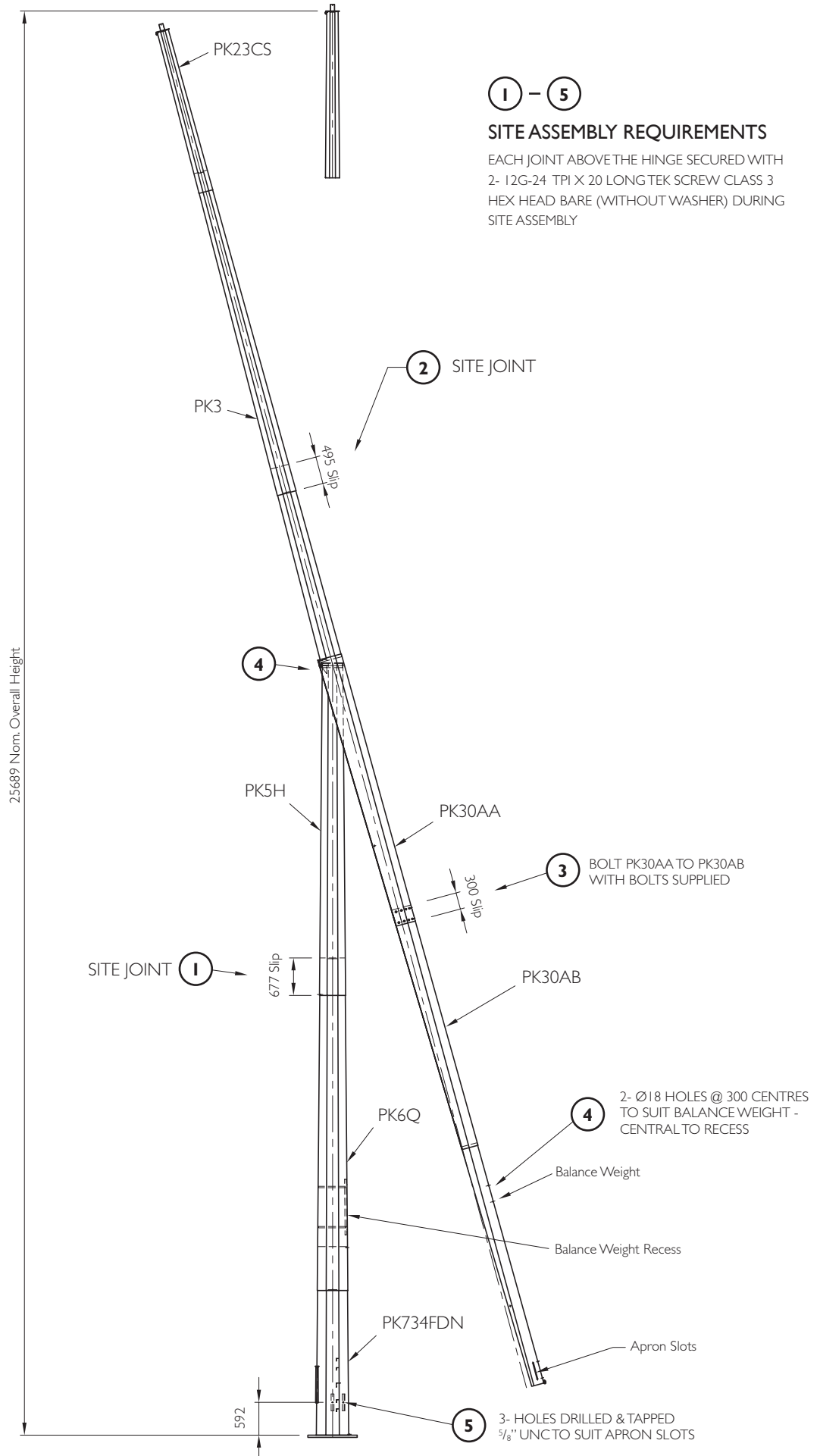

cables do not foul the balance weight. Cable guides are included adjacent to the balance weight recess (refer to figure 2).

NOTE: 25m Seesaw columns have stiffening plates at the hinge position. It is important that electrical cables run at the centre of the column between the two stiffening plates and that there is minimum of 1 metre slack in the cable length.

- 1.5 For erection of the column, refer to 8.6.02 Pole Assembly and Installation for Floodlight Poles.

Note: The orientation of the column on the foundation should take into account the direction of raising and lowering the column to ensure easy access.

Figure 2.

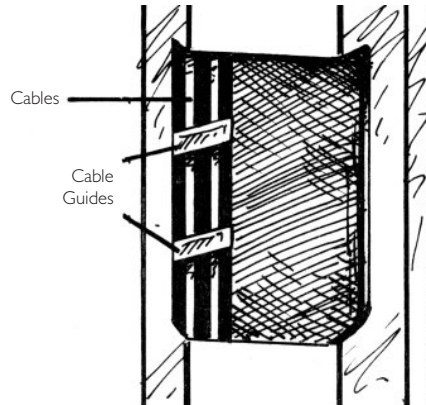

2.0 Raising and Lowering (refer to illustrations in figure 3)

IMPORTANT NOTE: The two bolts with washers marked "DANGER DO NOT REMOVE" are there to secure the balance weight and should not be removed without prior consultation with INGAL EPS.

- 2.1 Fasten adequate length of 12mm double braided rope to the rope hook at the base of the apron section.

Note: 25m Seesaw columns require 2 lengths of rope and 2 men acting in **UNISON** to raise/lower. Each rope length is to be a minimum of 1.7 times the column height.

- 2.2 Hold onto the rope or alternatively tie the rope off to a solid object and then remove the allen keyed apron-securing bolt.
- 2.3 Use the rope to first pull the apron away from the stub section and then allow the top section to gently swing downwards taking care to avoid jerking of the apron, which may be detrimental to the luminaires and the column.

WARNING: To prevent rope burns, always ensure suitable rope handling gloves are used (high grip, high flexibility mountaineering type). The use of 12mm double braided rope is recommended.

NOTE: It is important to ensure that the direction of pull on the rope is directly in line with the direction of raising and lowering of the column to ensure that no twisting is applied to the apron section.

- 2.4 Standing of the lowered column is the reverse procedure as described above.
- 2.5 Securely re-install the allen keyed apron securing bolt and remove the rope from the apron.

Figure 3. Raising and Lowering of Seesaw Columns

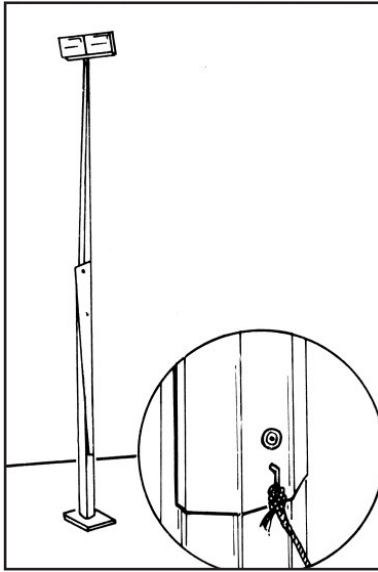

1. Fasten length of 12mm rope to the rope hook and secure.

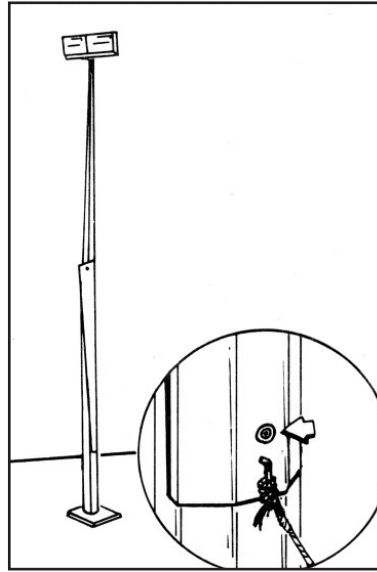

2. Remove allen keyed apron securing bolt.

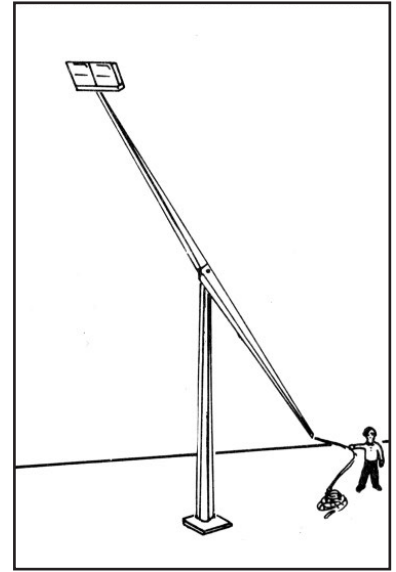

3. Pull apron away from stub section allowing the top section to gently swing downwards.

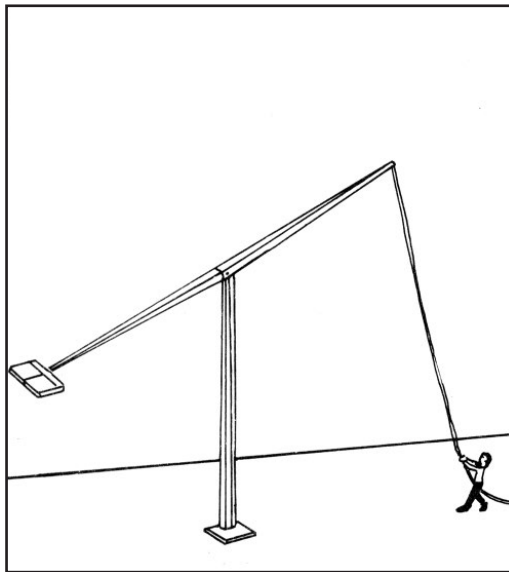

4. Complete operation, avoiding jerks, which may be detrimental to the luminaires as well as to the column.

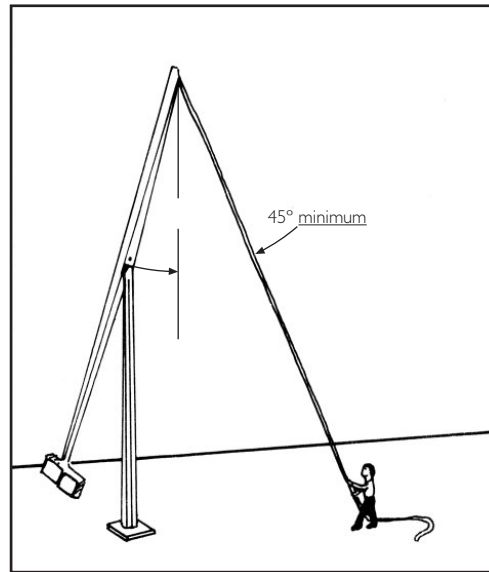

5. Raising of the lowered column is the reverse procedure, as described. Securely re-install the allen keyed apron securing bolt on completion of raising operation.