



A **valmont**  COMPANY

GRIPSPAN

• ROOFTREAD • SHURGRIP



An exceptional flooring option; in walkways, platforms, gantries and roof access

Gripspan meets the latest standards

AS1657 S4.5 now demands that any platform where people may have access to work beneath, must prevent a 15mm diameter ball falling through.

The nature of the Gripspan anti-slip profile offers unique anti-drop characteristics.

Unlike traditional grating or mesh alternatives, Gripspan even prevents small screws and bolts falling through.



Gripspan offers superior slip resistance

Independent test results highlight the exceptional anti-slip properties:

- A slip resistance rating of R13 based on the Oil Wet Ramp test.
- A BPN between 82 and 84 based on the Wet Pendulum test (depending on profile).

For more details see Locker TDS LIF105, available on our website.

Gripspan can span further

The roll formed plank design enables greater unsupported spans compared to traditional industrial flooring.

Fewer fixings and supports equals lighter weight, faster installation and lower total installed cost.

Spans of around 2m are possible in normal foot traffic applications.

Compliant with AS1657 when installed to specifications

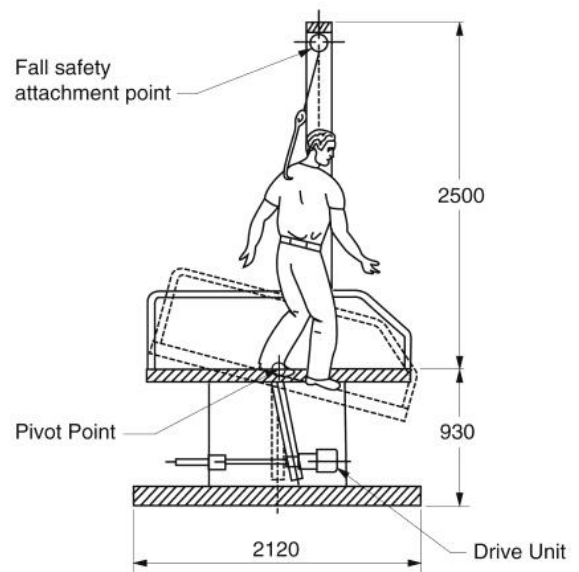

Oil-Wet ramp test



Gripspan Vs Traditional Grating

For the same given platform area, Gripspan requires fewer structural supports, saving

- up to 50% steel requirements
- up to 50% fabrication costs

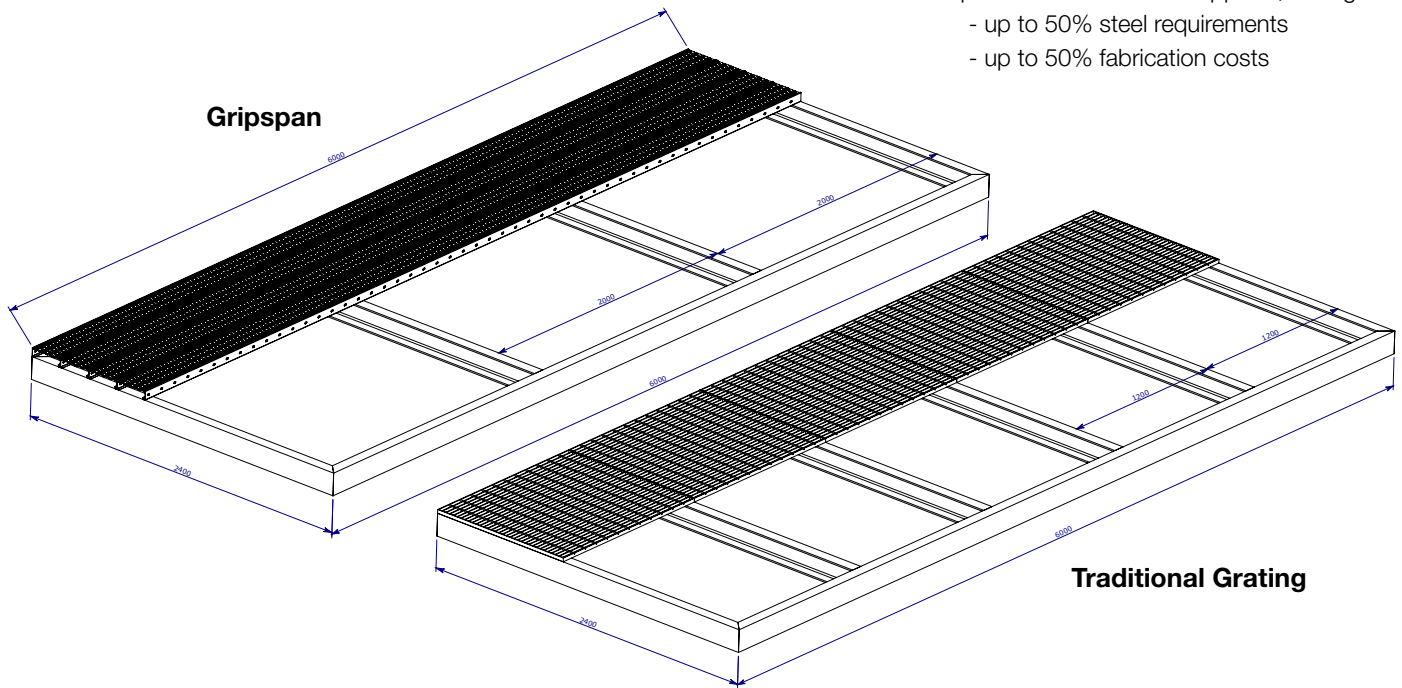

	Gripspan	Traditional Grating
Platform	6000 x 2400mm 14.4M ²	6000 x 2400mm 14.4M ²
Product	6512G/300PL	A255MPG
Product Weight	225 Kg	530 Kg
Support Frame (HDG)	405 Kg	495 Kg
Total Weight	630 Kg	1025 Kg
Welded Joints	8	12

Application Advice

Please find below a suggested Gripspan product and profile for a variety of standard applications. Please note, this is not the only option, Webforge Locker can provide other product and spanning combinations based on the exact requirements of your specific project.

Consult your Webforge Locker technical sales representative for advice on your exact requirements.

Application	Product	Max Span*
Condensor Platforms	6512G/300 PL	2100mm
Condensor Platforms	6520G/300 PL	2400mm
Elevated Water Tower Platform	6520G/225 SL	2100mm
Roof Access Walkway	6512G/300 PL	2100mm
Mezzanine Flooring	6512G/225 SL or SLD	2100mm
Rail Bridge Access Walkway	6512G/300 PL or SR	2100mm
Mining – Various platform / Walkway	All ranges pending requirements	
Sale Yard – Auctioneers walkway	6512G/300 PL	2100mm
Sale Yard – Auctioneers walkway	6520G/225 SLD	2400mm
Stair Treads	6520G/225 PL, SL, SLD, SR	1200mm

See fixing options on page 10

* Based on ASNZ1657

Profiles

Diamond

225mm plank width: 65mm or 100mm leg height
300mm plank width : 65mm leg height

Plain (PL)

Serrated (SR)

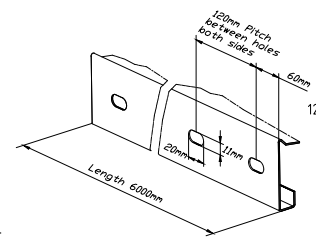
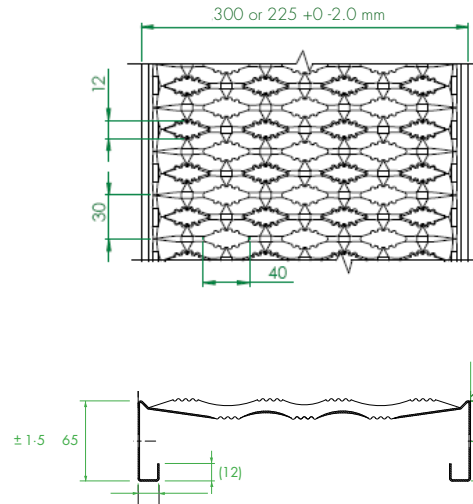
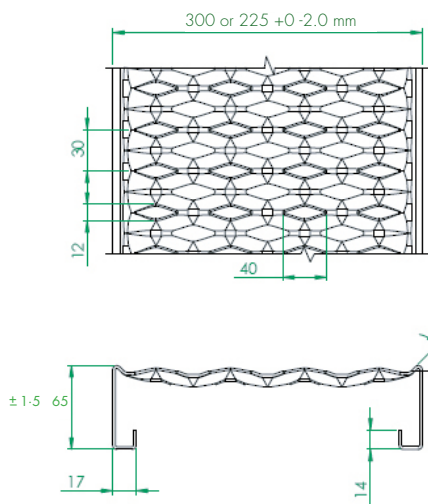

Leg/Width	A
65/225	34mm
65/300	36mm
100/225	69mm

A = Edge to hole centre

Slotted

225mm plank width: 65mm leg height

Slotted (SL)

Slotted Dimpled (SLD)

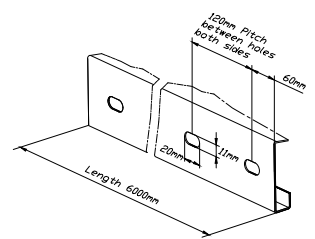
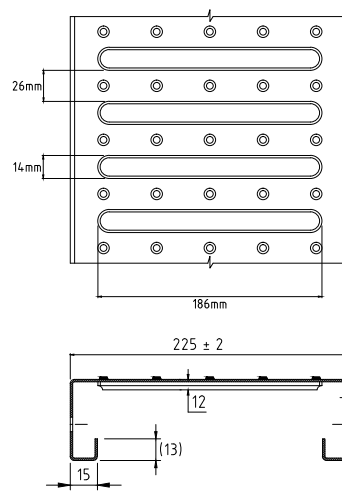
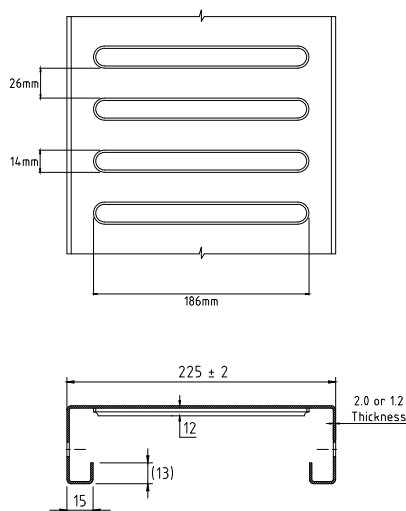

Leg/Width	A
65/225	33mm

A = Edge to hole centre

Planks are also available in dimpled only, no slots.
Made to order, minimum quantities apply.

* For detailed drawings visit website.

Load Tables

Type	Kgs per lin metre	Kgs per standard 6m length		300 mm Width									
				Span (mm)									
				600	750	900	1200	1500	1800	2100	2400	2700	3000
6512G	4.7	28.20	U	40.5	25.5	20.1	11.1	6.9	4.8	3.1	1.9	1.3	0.7
Galv			D	3.0	3.8	4.5	6.0	7.5	9.0	10.0	10.0	10.0	10.0
65mm x 1.2mm thick			C	4.6	3.7	2.9	2.3	1.8	1.5	1.2	0.8	0.6	0.4
6520G	7.6	45.60	U	101.3	65.6	44.5	22.4	12.5	7.9	4.6	2.7	1.8	1.2
Galv			D	3.0	3.7	4.5	6.0	7.5	9.0	10.0	10.0	10.0	10.0
65mm x 2.0mm thick			C	9.3	9.1	7.5	5.1	3.5	2.5	1.65	1.25	0.9	0.63
6520A	2.7	16.20	U			18.6	10.1	5.5	3.5	2.2			
Aluminium			D			4.5	6.0	7.5	9.0	10.0			
65mm x 2.0mm thick			C			2.3	1.9	1.5	1.3	1.1			

Type	Kgs per lin metre	Kgs per standard 6m length		225 mm Width																			
				Span (mm)																			
				600	750	900	1200	1500	1800	2100	2400	2700	3000										
6512G	4.03	24.18	U	116.0	87.0	73.0	51.0	52.0	35.0	31.0	17.6	21.0	10.2	14.0	5.9	11.0	3.9	8.0	2.3	6.0	1.4	5.0	1.0
Galv			D	4.0	3.0	5.3	3.75	6.7	4.5	10.6	6.0	15.4	7.5	21.2	9.0	28.5	10.0	35.5	10.0	44.0	10.0	53.0	10.0
65mm x 1.2 mm thick			C	7.5	7.5	6.4	6.0	5.6	5.0	4.3	3.4	3.4	2.4	2.9	1.7	2.4	1.2	2.1	0.8	1.9	0.6	1.7	0.45
			D	3.0	3.0	4.2	3.75	4.8	4.5	7.5	6.0	11.0	7.5	15.0	9.0	20.0	10.0	25.5	10.0	31.5	10.0	38.0	10.0
6520G	6.4	38.4	U	230.0	125.0	145.0	81.0	104.0	55.0	60.0	27.7	37.0	15.4	26.0	9.8	18.0	5.7	14.0	3.4	12.0	2.3	10.0	1.5
Galv			D	5.5	3.0	6.7	3.75	8.5	4.5	13.0	6.0	18.0	7.5	24.0	9.0	31.5	10.0	41.0	10.0	52.0	10.0	65.0	10.0
65mm x 2.0 mm thick			C	15.4	9.3	12.5	9.1	10.5	7.5	8.0	5.1	6.3	3.5	5.2	2.5	4.5	1.65	3.9	1.25	3.5	0.9	3.2	0.6
			D	4.0	3.0	5.0	3.75	6.3	4.5	9.5	6.0	13.5	7.5	18.5	9.0	24.5	10.0	31.2	10.0	39.0	10.0	48.0	10.0
10012G	4.71	28.2	U	150.0	150.0	110.0	110.0	82.0	82.0	52.0	52.0	34.0	34.0	23.0	20.0	18.0	12.7	14.0	7.2	12.0	4.6	10.0	2.9
Galv			D	2.0	2.0	2.6	2.6	3.3	3.3	5.0	5.0	7.4	7.4	10.4	9.0	14.2	10.0	19.5	10.0	26.3	10.0	34.5	10.0
100mm x 12 mm thick			C	10.2	10.2	9.2	9.2	8.3	8.3	6.9	6.9	5.7	5.7	4.8	4.8	4.1	3.8	3.6	2.5	3.1	1.6	2.8	1.1
			D	1.7	1.7	2.0	2.0	2.6	2.6	3.8	3.8	5.6	5.6	7.8	7.8	10.8	10.0	14.5	10.0	19.5	10.0	25.5	10.0
10020G	7.6	45.6	U	340.0	340.0	220.0	217.0	170.0	150.0	105.0	81.0	70.0	46.0	47.0	27.0	35.0	17.5	27.0	10.6	20.0	6.4	15.0	3.9
Galv			D	2.9	2.9	3.8	3.75	3.1	4.5	7.8	6.0	11.3	7.5	15.3	9.0	20.0	10.0	25.5	10.0	31.4	10.0	38.3	10.0
100mm x 2.0 mm thick			C	22.0	22.0	19.3	19.3	17.3	17.3	14.1	14.1	11.8	11.1	9.6	7.9	8.0	5.6	6.8	3.8	6.0	2.5	5.3	1.9
			D	2.3	2.3	3.0	3.0	3.8	3.8	5.7	5.7	8.0	7.5	10.9	9.0	14.2	10.0	18.0	10.0	24.5	10.0	27.4	10.0
6525A*	2.7	16.2	U	118.0	29.5	76.3	22.5	52.8	17.6	30.0	10.9	19.3	6.6	13.0	4.0	10.0	2.6	8.0	1.7	6.3	1.0	5.0	0.7
Aluminium			D	12.0	3.0	12.7	3.75	13.5	4.5	16.5	6.0	22.0	7.5	29.5	9.0	38.0	10.0	47.5	10.0	61.5	10.0	75.0	10.0
65mm x 2.5 mm thick			C	8.0	2.8	6.4	2.7	5.4	2.6	4.0	2.0	3.3	1.6	2.7	1.2	2.4	0.90	2.1	0.6	1.9	0.4	1.8	0.3
			D	8.5	3.0	8.9	3.75	9.3	4.5	11.5	6.0	15.5	7.5	21.0	9.0	28.0	10.0	36.0	10.0	44.5	10.0	54.0	10.0
10025A*	3.2	19.2	U	155.6	34.6	106.7	28.6	77.8	24.1	46.9	18.2	29.6	13.5	21.0	10.5	15.4	7.4	11.1	4.6	9.5	3.3	8.0	2.0
Aluminium			D	13.5	3.0	14.0	3.75	14.5	4.5	15.5	6.0	16.5	7.5	18.0	9.0	20.7	10.0	24.0	10.0	28.9	10.0	41.0	10.0
100mm x 2.5 mm thick			C	10.5	3.3	9.0	3.4	7.9	3.6	6.1	3.7	5.0	3.5	4.2	3.0	3.6	2.50	2.9	2.0	2.8	1.3	2.6	0.9
			D	9.5	3.0	10.0	3.75	10.0	4.5	10.0	6.0	10.6	7.5	12.5	9.0	14.5	10.0	15.0	10.0	21.5	10.0	29.5	10.0

* MTO: Conditions apply.

NB:

Figures in Red are for maximum safe working load
 Figures in Black are for normal working load, based
 on span/200 or 10 mm, whichever is the least

- U = Safe uniformly distributed load in kilopascals
- C = Safe line load normal to plank width in kilonewtons
- D = Deflection in millimetres

Spans in tables are clear spans between supports.
 Recommended minimum support 25mm (40mm preferred).

Figures in Load Tables apply to single simply supported planks.
 Multiple planks correctly installed and joined would have a higher load capacity.

Standard Planks

PART NUMBER	Profile	Plank Length mm	PLANK WIDTH mm	PLANK HEIGHT mm	WEIGHT PER LINEAL METER	MATERIAL THICKNESS mm
DIAMOND TREAD GALVABOND						
6512G/225-PL	PLAIN	6000 (5800 NZ)	225	65	4.03	1.2
6512G/225-SR	SERRATED	6000 (5800 NZ)	225	65	4.03	1.2
6520G/225-PL	PLAIN	6000 (5800 NZ)	225	65	6.4	2
6520G/225-SR	SERRATED	6000 (5800 NZ)	225	65	6.4	2
DIAMOND TREAD ALUMINIUM						
6512G/300-PL	PLAIN	6000 (5800 NZ)	300	65	4.7	1.2
6512G/300-SR	SERRATED	6000 (5800 NZ)	300	65	4.7	1.2
6520G/300-PL	PLAIN	6000 (5800 NZ)	300	65	7.6	2
6520G/300-SR	SERRATED	6000 (5800 NZ)	300	65	7.6	2
SLOTTED TREAD						
6512G/225-SL	SLOTTED	6000 (5800 NZ)	225	65	4.03	1.2
6512G/225-SLD	SLOTTED DIMPLED	6000 (5800 NZ)	225	65	4.03	1.2
6520G/225-SL	SLOTTED	6000 (5800 NZ)	225	65	6.4	2
6520G/225-SLD	SLOTTED DIMPLED	6000 (5800 NZ)	225	65	6.4	2

** Please note other materials and finishes are available, conditions apply.

*** Custom lengths are available, cutting charges apply

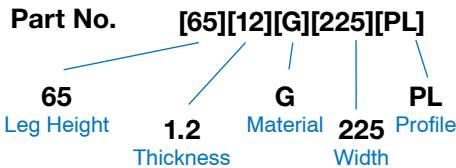

MATERIALS OPTIONS

G = Galvabond

MS = Mild Steel

HDG = Hot Dipped Galvanised

A = Aluminium

Stair Treads

Gripspan and Shur-Grip stair treads can be fabricated by fitting separately supplied end plates to sections of Gripspan planking. Alternatively, fully fabricated stair treads can be supplied in either standard or heavy duty form.

- Standard Tread – Galvanized steel or HDG**
 No nosing, endplates fitted with fixing holes, all welds painted with zinc rich primer. Hot Dipped Galvanising optional.
- Heavy Duty Tread**
 Floor plate nosing, end plates fitted with fixing holes, hot dipped galvanised, wider treads



STANDARD TREAD		HEAVY DUTY TREAD	
LENGTH	WIDTH	LENGTH	WIDTH
600	225 / 300	600	262
750	225 / 300	750	262
900	225 / 300	900	262
1000	225 / 300	1000	262
1200	225 / 300	1200	262

Roof Tread™ Systems

The Roof Tread system provides a complete roof access system, with the option to specify handrails on one or both sides. Roof Tread also offers a specifically designed angle bracket which raises the walkway platform (and handrails) to a level walking surface, regardless of the roof angle between 5° and 20°. Traditionally supplied in 600mm wide walking surface (Roof Tread™ 600) the system is also available in 900, utilising 3 Gripspan planks side by side.

All walkways, handrails and Roof Tread systems are designed to meet the relevant requirements of ASNZ 1657 and various statutory codes of practice.

Roof Tread Series are named based on the width of the total walkway; additional components to the system are included in the part number system as follows:

Roof Tread Series	Comprises
RT600	2 x 300mm Gripspan Planks
RT601	2 x 300mm Gripspan Planks & Handrail on 1 side
RT601A	2 x 300mm Gripspan Planks, Handrail on 1 side & Angle fixing
RT602	2 x 300mm Gripspan Planks & Handrail on 2 sides
RT602A	2 x 300mm Gripspan Planks, Handrail on 2 sides & Angle fixing
RT675	3 x 225mm Gripspan Planks
RT900	3 x 300mm Gripspan Planks



Shur-Grip

Shur-Grip standard planks are manufactured and available in:

- 225 or 300mm wide planks and stair treads
- 6100mm length standard plank (5800mm in NZ)
- 2.0 or 3.0mm steel thickness
- 40 or 50mm leg heights
- Galvabond, untreated mild steel & hot dipped galvanized

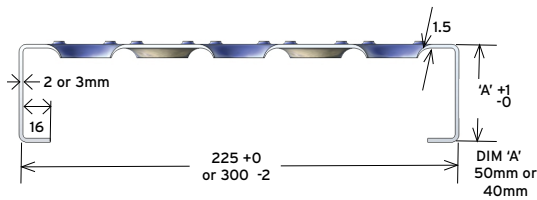
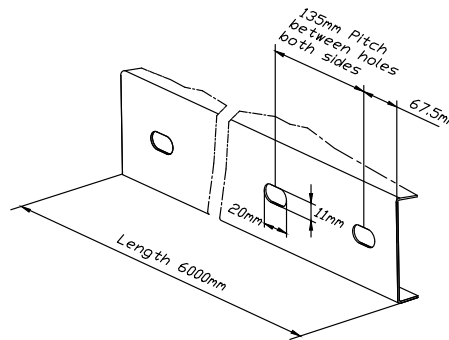
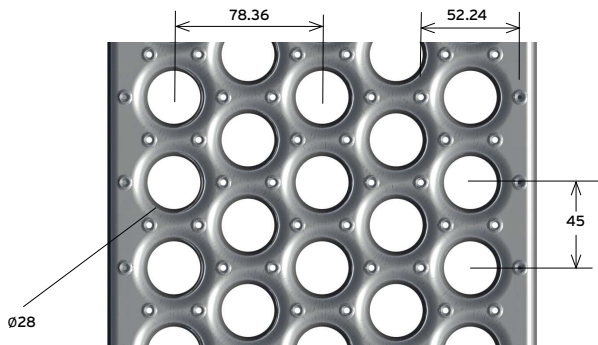

* For detailed drawings visit the website.

Shur-Grip Carrier Plates (SGCP)

- Weld to plank ends
- Suitable for joining planks end to end with M10 x 20mm bolt assemblies
- Used for fabrication of stair treads

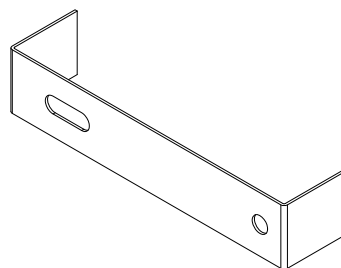
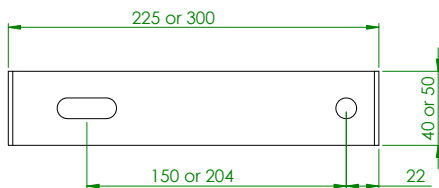

Shur-Grip Toe Boards



Standard toe boards are available to suit both 40mm & 50mm leg heights. Toe boards are 3000mm long and can be fixed with M10 x 20 long bolt assemblies at 540mm centres.

Shur-Grip bolt assemblies (SGBA) are available to suit different plank heights; please specify plank height when ordering

- Non standard bolt sizes available on request
- Treads available with floor plate nosing or abrasive nosing



Load Table

Type	Kgs per lin metre	Kgs per standard plank (6100mm)		300mm Width							
				Span (mm)							
				900	1200	1500	1800	2100	2400	2700	3000
SG4020/300	6.4	39.04	U	16.67	7.98	4.05	2.46	1.55	0.95		
			D	4.50	6.00	7.50	9.00	10.00	10.00		
			C	2.81	1.80	1.14	0.83	0.55	0.37		
			D	4.50	6.00	7.50	9.00	10.00	10.00		
SG5020/300	6.72	40.99	U	23.43	12.57	6.19	4.13	2.45	1.58	0.99	0.64
			D	4.50	6.00	7.50	9.00	10.00	10.00	10.00	10.00
			C	3.95	2.83	2.00	1.39	0.94	0.63	0.44	0.32
			D	4.50	6.00	7.50	9.00	10.00	10.00	10.00	10.00
SG4030/300	9.59	58.50	U	24.02	11.67	6.29	3.87	2.35	1.36		
			D	4.50	6.00	7.50	9.00	10.00	10.00		
			C	4.05	2.63	1.77	1.31	0.83	0.55		
			D	4.50	6.00	7.50	9.00	10.00	10.00		
SG5030/300	10.09	61.55	U	38.75	18.70	10.25	6.03	3.86	2.37	1.50	1.02
			D	4.50	6.00	7.50	9.00	10.00	10.00	10.00	10.00
			C	6.54	4.21	2.88	2.04	1.29	0.86	0.60	0.44
			D	4.50	6.00	7.50	9.00	10.00	10.00	10.00	10.00



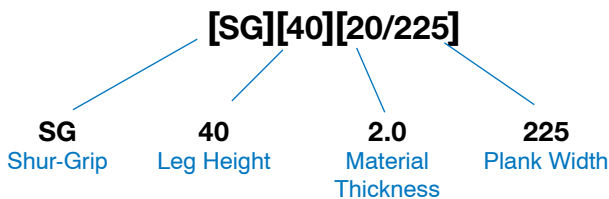

Type	Kgs per lin metre	Kgs per standard plank (6100mm)		225mm Width							
				Span (mm)							
				900	1200	1500	1800	2100	2400	2700	3000
SG4020/225	5.17	31.54	U	21.96	8.69	3.97	2.29	1.32	0.77		
			D	4.50	6.00	7.50	9.00	10.00	10.00		
			C	2.73	1.35	1.01	0.58	0.38	0.24		
			D	4.50	6.00	7.50	9.00	10.00	10.00		
SG5020/225	5.49	33.49	U	30.91	15.01	8.26	4.87	2.97	1.76	1.15	0.76
			D	4.50	6.00	7.50	9.00	10.00	10.00	10.00	10.00
			C	3.91	2.53	1.74	1.23	0.87	0.58	0.41	0.30
			D	4.50	6.00	7.50	9.00	10.00	10.00	10.00	10.00
SG4030/225	7.75	47.28	U	26.47	11.67	8.30	4.43	2.23	1.63		
			D	4.50	6.00	7.50	9.00	10.00	10.00		
			C	3.35	1.97	1.50	1.12	0.68	0.46		
			D	4.50	6.00	7.50	9.00	10.00	10.00		
SG5030/225	8.24	50.26	U	44.05	19.21	10.93	7.68	4.49	2.43	1.77	1.19
			D	4.50	6.00	7.50	9.00	10.00	10.00	10.00	10.00
			C	5.57	3.24	2.30	1.67	1.19	0.80	0.56	0.41
			D	4.50	6.00	7.50	9.00	10.00	10.00	10.00	10.00

NB: **U** = Safe uniformly distributed load in kilopascals
C = Safe line load normal to plank width in kilonewtons
D = Deflection in millimetres

Shur-Grip part numbers are coded as follows:

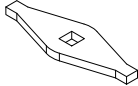
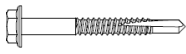

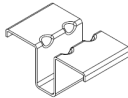
Planking Fixing Clips & Accessories

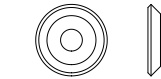
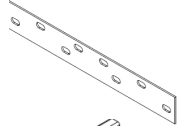
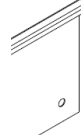
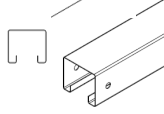
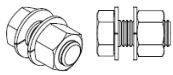
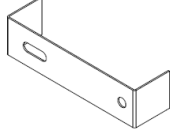
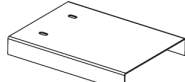
	COMMON NAME	PART NUMBER	DESCRIPTION
	Hold Down Clamp	HDC65 HDC 100 (100 leg) SGHDC (Shurgrip) HDC65-AL	Securing plain or serrated profiles to steelwork without welding or drilling. SGHDC for securing Shurgrip plank. To secure Aluminium planks to structural steel
	Anchor Device Clamp	ADC (Galv) ADC-AL (Aluminium) ADC SS (Stainless)	Securing plain or serrated SR profiles to steelwork with the use of 14-10X80 drilling screw.
	Self Drilling Screw	14-10X80	To suit ADC diamond washer when fixing PL or SR onto steelwork
	J Bolt with nut & washer	J-Bolt-M8 (Galv)	Fix plank range to supporting members from underside. Drilling into steelwork is required
	Slotted Fixing Clip	SLC65 SLC65-HM	Securing slotted SL or slotted dimpled SLD to steelwork from above with 10-24X65mm self drilling screw
	Self Drilling Screw	10-24X65	To suit SLC 65 when fixing SL or SLD planks into steelwork
	Shurgrip anchor disc	SGAD	To suit Shurgrip profiles when fixing into steelwork using 14-10X80 self drilling screws
	Splice Plate	SP65 (65mm leg height) SP100 (100mm leg height)	Used to splice planks end on end using HXB-10mm, SP65 are fitted parallel to plank inside of the leg (65mm, or 100mm)
	Kickplate / Heel Toe Plate	HT65G (Galvabond) HT65HDG (HD Galvanized) HT65/215 (to suit 100mm leg)	Bolt on kick plate with holes pre-punched Fixed with HXB-8mm bolts.
	Filler Panel	FP65G	Used to make-up piece 75mm wide. Fixed using HXB-8mm bolts. Other widths available on request.
	Joining Bolts	HXB-8MM HXBSS-8MM (stainless steel) HXB-10MM	To join planks side by side at mid span and also to fix accessories to planks
	End Plates / Carrier Plates	CPL65G-300 CPL65G-STD	Used when fabricating planks for use as stair treads. Can be used also to bolt planks end on end. End plates are welded into the ends of planks.
	Expansion Brackets	JB 225-SL JB 300-SR	Expansion brackets used when expansion is required on walkways/platforms, eg. Bridges.

Installation Guide

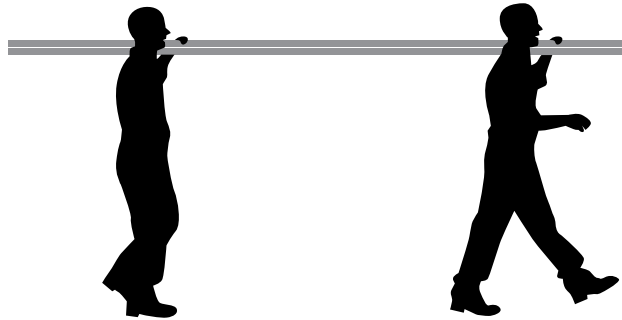

Gripspan Planking is cost effective; in both material and installation. The light-weight planks are easy to handle, meaning Gripspan can be handled by two people. Utilising the Gripspan Roof Tread system will ensure even difficult roof pitches are easy to access.

Gripspan is roll formed, hence the planks are available in virtually any transportable length, and can be easily welded or clamped into place to suit many applications.

Planks can be supplied in pre-bolted modules, or fabricated to suit individual applications and fixing methods. The following information is designed to provide a guide to successful installation; however it is not a substitute for specific engineering calculations that may be required for individual applications. The manufacturer accepts no responsibility for the incorrect installation of Gripspan Planking.

IMPORTANT: Prior to installation ensure that your choice of Gripspan Planking is suitable for the loading and spanning requirements involved. This information is detailed in the Load Tables on page 7.

Installation Tips

Gripspan Planking may be welded or clamped into place.

- If clamping, it is recommended that planks are locked together using a bolt assembly (Part No. HXB8MM) through the plank side holes, which are at 120mm intervals. Bolt spacing is recommended at mid span, between supports
- If welding panels; Webforge Locker recommends a 6mm fillet weld, 25mm in length to weld the plank onto the support structure.
- Welding adjacent planks together is also recommended via a 6mm fillet weld, 25mm in length; staggered top and bottom of each plank, every 600mm.

NOTE: Weld points should be cleaned and immediately coated with zinc rich paint, as per AS/NZ 4680.

- If fixing planks to structural steel, use HDC65 or HDC65-AL every 4th plank.

General Tips

- If bolting panels together, allow for bolt hole alignment when cutting Gripspan Planks.
-  When first laying Gripspan planking onto a support, take caution as unsecured planks are not safe to walk on.
- To allow for installation tolerances and future movement in the support structure.
 - Keep Gripspan planking at least 6mm away from vertical steel sections and at least 12mm away from concrete walls.
 - Allow clearance of at least 6mm at the side and end of planks, and between section joints.



A **valmont**  COMPANY



A **valmont**  COMPANY

Webforge Locker

Email: info@locker.com.au
info@webforge.com.au

Websites: www.locker.com.au
www.webforge.com.au

TOLL FREE 1800 635 947

Webforge Locker (NZ)

Email: sales@lockernz.co.nz
nz_sales@webforge.co.nz

Websites: www.lockernz.co.nz
www.webforge.co.nz

TOLL FREE 0800 285 837