

Decorative Lamp Post - SR4 / Base D8S

- Smooth, straight non-tapered, 4-inch diameter, reinforced composite pole shaft
- Direct embedded and anchor base models
- One piece XTREME® elastomeric urethane base cover

Ordering Information

Sample Catalog Number Logic

	B	C	D	E	F	G
SR4-D8S	12	DE	DGR	40	-30	
SR4-D8S	12	AB	BLK	27	-35	RC
Pole and Base Design	Above Grade Height	Installation Method	Color	Tenon O.D.	Tenon Height	Options

B Above Grade Height

Cat No.	Description
6	6 feet /1.83 M
7	7 feet /2.13 M
8	8 feet /2.44 M
9	9 feet /2.74 M
10	10 feet /3.05 M
11	11 feet /3.35 M
12	12 feet /3.66 M

C Installation Method

Cat No.	Description
DE	Direct Embedded
AB	Anchor Base

D Color

Cat No.	Description
BLK	Black
MTB	Matte Black
DBZ	Dark Bronze
DGR	Dark Green
HTG	Hunter Green
SLV	Silver
WHT	White
GRY	Grey
CC	Custom Color - Please provide a min. 3" x 3" color chip.
RAL	Please provide a four digit RAL color number.

E Tenon O.D. (Outside Diameter)

Cat No.	Description
23	2 3/8" (60 mm)
27	2 7/8" (73 mm)
30	3" (76 mm) nominal
35	3 1/2" (89 mm)
40	4" (102 mm)

F Tenon Height

Cat No.	Description
-30	3.0" (76 mm)
-35	3.5" (89 mm)
-40	4.0" (102 mm)
-50	5.0" (127 mm)

- For other tenon sizes contact the factory.

G Options

Cat No.	Description
RC	Receptacle housing and a NEC-approved cover with 15A GFCI receptacle. Standard location is 12"/305 mm below the top of the pole.

- Other accessories are shown on the Accessories specification sheet.

ABOVE GRADE
HEIGHT
12' MODEL
SHOWN

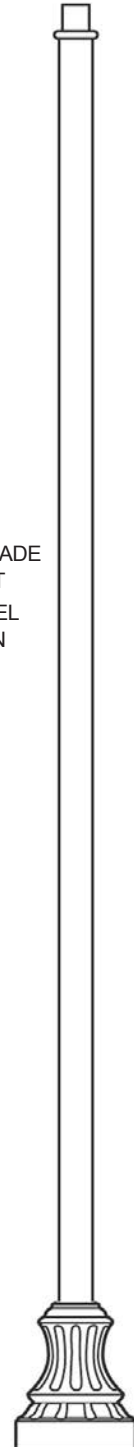

HEIGHT: 15"/380 mm

BASE DIAMETER: 12"/305 mm

SR4-D8S Smooth straight 4-inch diameter pole shaft

Specifications

POLE SHAFT

The composite lamp post shall be smooth straight. The post shall be 4 inches (102 mm) in diameter with a nominal wall thickness of .28 inches (7 mm). The hand hole shall be 2 inches (51 mm) x 4 inches (102 mm) with a cover. The post shall be constructed of fiberglass reinforced polyester resin utilizing glass roving, continuous strand mat and off axis fibers oriented for optimum strength and rigidity. The post shall be non-conductive and chemically inert.

PERFORMANCE CRITERIA

The post shall be designed with a minimum safety factor of 1.5:1 and have no more than a 10% deflection at full wind loading. The post shall deflect no more than 2.5% of the above-ground length with 100 lbs of lateral top load (stiffness). Poles shall be tested and rated per ANSI C136.20-2012.

DIRECT EMBEDDED INSTALLATION

Direct embedded poles shall have a 2 inch (51 mm) x 4 inch (102 mm) hole for conduit entrance 24 inches (610 mm) below finished grade. Embedded depths may vary per local codes, site soil conditions, drainage and very high wind conditions.

ANCHOR BASE INSTALLATION

Anchor bases shall be constructed of galvanized steel or 6061-T6 aluminum base. The base shall be factory bonded to the post. The anchor base shall have four holes at ninety degrees, accommodating a bolt circle of 7 inches (178 mm) to 9 inches (230 mm).

POST TOP

A painted A356-T6 aluminum tenon shall be firmly bonded to the pole for mounting a post-top luminaire or arm.

FINISH

The surface of the post shall be uniform and consistent for the entire length of the post. A UV-resistant catalyzed urethane coating shall be extremely durable and retains its gloss after a 5000 hour exposure test per ASTM G154, with no dulling or chalking of the surface.

ORNAMENTAL BASE COVER

The ornamental decorative base cover shall be one piece and constructed from a proprietary elastomeric urethane and finished to match the post. The base shall be corrosion free and extremely resistant to impact and chipping.

Direct Embedded - DE

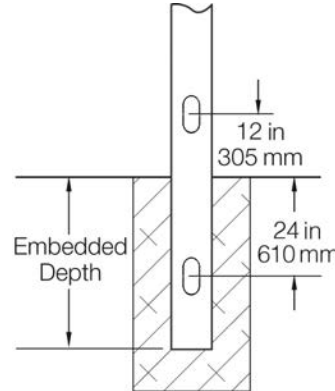

Shaft Length	Embedded Depth
6 to 12 ft	3 ft / .91 M

Anchor Base Installation - AB

Bolts: 5/8" x 21" x 3" Galvanized with 8 washers and 4 nuts.

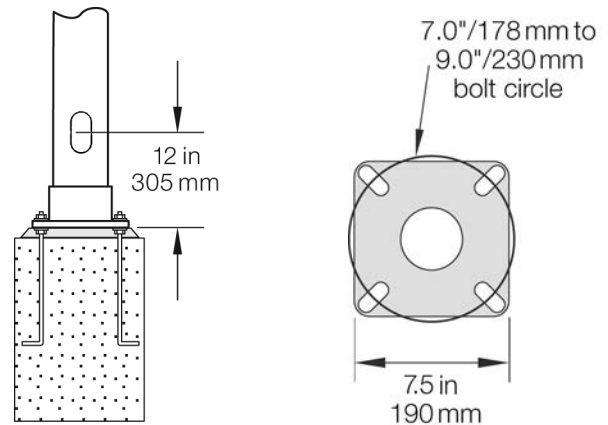

Wind Loading Data

Cat No.	Description	WT	WIND SPEED (MPH) WITH 3 SECOND GUST FACTOR						
			90	100	110	120	130	140	150
6	6 feet/1.83 M	29	18.7	15.0	12.3	10.2	8.7	7.4	6.4
7	7 feet/2.13 M	33	16.4	13.1	10.7	8.9	7.5	6.4	5.6
8	8 feet/2.44 M	36	12.3	11.3	9.2	7.7	6.5	5.5	4.8
9	9 feet/2.74 M	39	12.4	9.8	8.0	6.6	5.6	4.7	4.1
10	10 feet/3.05 M	42	10.9	8.6	7.0	5.8	4.8	4.1	3.5
11	11 feet/3.35 M	46	9.7	7.5	6.1	5.0	4.2	3.5	3.0
12	12 feet/3.66 M	49	8.5	6.6	5.3	4.4	3.6	3.0	2.6

Wind speed values are for a 3 second gust per ASCE.

Calculated per ANSI C136.20-2012. 1.0 Importance factor.

Assumes load 12 inches above the pole top. Safety factor = 1.5:1.

Contact the factory for AASHTO or specific local codes.