

Decorative Lamp Post - CF50 / Base D4M

- Fluted, tapered composite pole
- Direct embedded and anchor base models
- XTREME® elastomeric urethane base cover

Ordering Information: Sample Catalog Number Logic

	B	C	D	E	F
CF50-D4M	12	AB	BLK	30	RC
CF50-D4M	16	DE	WHT	40	•
Pole and Base Design	Above Grade Height	Installation Method	Color	Tenon O.D.	Options

B Above Grade Height

Cat No.	Description
6	6 feet /1.8 M
7	7 feet /2.1 M
8	8 feet /2.4 M
9	9 feet /2.7 M
10	10 feet /3.0 M
11	11 feet /3.4 M
12	12 feet /3.7 M
13	13 feet /4.0 M
14	14 feet /4.3 M
15	15 feet /4.6 M
16	16 feet /4.9 M
17	17 feet /5.2 M

C Installation Method

Cat No.	Description
DE	Direct Embedded
AB	Anchor Base

D Color

Cat No.	Description
BLK	Black
DBZ	Dark Bronze
DGR	Dark Green
SLV	Silver
WHT	White
GRY	Grey
CC	Custom Color - Please provide a min. 3" x 3" color chip.
RAL	Please provide a four digit RAL color number.

E Tenon O.D. (Outside Diameter)

Cat No.	Description
30	3" (76 mm) O.D.
40	4" (102 mm) O.D.
99	Custom Tenon O.D.

- For other tenon sizes contact the factory.

F Options

Cat No.	Description
RC	Receptacle housing and a NEC-approved cover with 15A GFCI receptacle. Standard location is 12"/305 mm below the top of the pole.

- Other accessories are shown on the Accessories specification sheet.

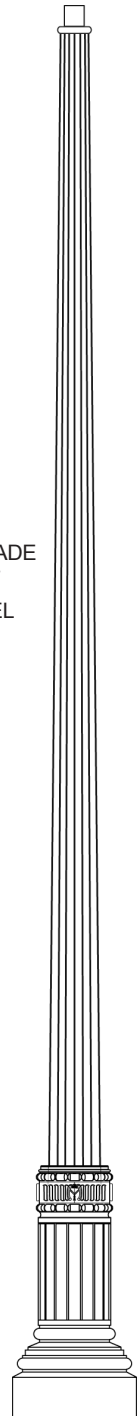

ABOVE GRADE
HEIGHT
17' MODEL
SHOWN

HEIGHT: 45"/1143 mm

BASE DIAMETER: 22.5"/571 mm

CF50-D4M Fluted, tapered composite pole shaft

Direct Embedded - DE

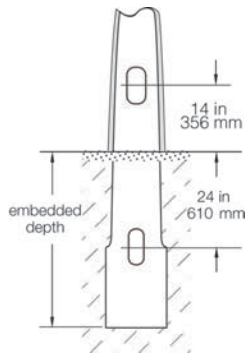

Shaft Length	Embedded Depth
6 to 13 ft	3 ft / .91 M
14 to 17 ft	4 ft / 1.2 M

* Embedded depths may vary per local codes, site soil conditions, drainage and very high wind conditions.

Anchor Base Installation - AB

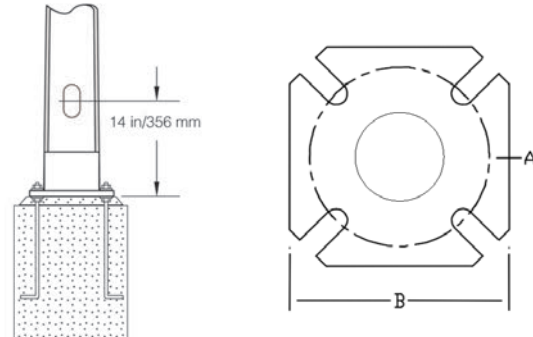

Specifications

POLE SHAFT

The CF50 pole shaft shall be round tapered with 16 flutes and a .14"/3.6 mm per foot taper. The hand hole shall be 2.5"/64 mm x 5"/127 mm with a cover. The shaft shall be constructed using an advanced resin transfer manufacturing process to produce an ornamental pole with extremely precise detail on the shaft flutes. The shaft shall be non-conductive and chemically inert. The fluting extends to the end of the pole and on embedded-type post shall serve as a resistance to rotation.

PERFORMANCE CRITERIA

The post shall be designed with a minimum safety factory of 1.5:1 and have no more than a 15% deflection at full wind loading. The post shall deflect no more than 2.5% of the above grade length with 100 lbs of lateral top load (stiffness). Poles shall be tested and rated per ANSI C136.20-2012.

DIRECT EMBEDDED INSTALLATION

Direct embedded poles shall have two 2.5 inch (64 mm) diameter holes at 180 degrees for conduit entrance 24 inches (610 mm) below finished grade. Embedded depths may vary per local codes, site soil conditions, drainage and very high wind conditions.

ANCHOR BASE

Anchor bases shall be constructed of hot dipped galvanized steel. The base shall be factory bonded to the post. The anchor base shall have four holes at ninety degrees, accommodating a bolt circle as indicated by the chart.

POST TOP

A painted aluminum or galvanized steel tenon shall be factory bonded to the pole for mounting a post-top luminaire or arm.

FINISH

The surface of the pole shall be uniform and consistent for the entire length of the post. A UV-resistant catalyzed urethane coating shall be extremely durable and retains its gloss after a 5000 hour exposure test per ASTM G154, with no dulling or chalking of the surface.

ORNAMENTAL BASE COVER

The ornamental decorative base cover shall be one or two piece and constructed of a proprietary elastomeric urethane and finished to match the post. The base shall be corrosion free and extremely resistant to impact and chipping.

Shaft Length	Bolt Circle (A)	Base Plate Size (B)	Anchor Bolts
6' - 17' (1.8 M to 5.2 M)	9" - 11" (229 mm - 279 mm)	10" (254 mm)	3/4" x 30"

Wind Loading Data

Cat No.	Description	WT	WIND SPEED (MPH) WITH 3 SECOND GUST FACTOR							
			90	100	110	120	130	140	150	
6	6 feet/1.8 M	55	11.9	9.4	7.5	6.1	5.0	4.2	3.6	
7	7 feet/2.1 M	58	11.9	9.4	7.5	6.1	5.0	4.2	3.6	
8	8 feet/2.4 M	61	11.9	9.4	7.5	6.1	5.0	4.2	3.6	
9	9 feet/2.7 M	64	11.9	9.4	7.5	6.1	5.0	4.2	3.5	
10	10 feet/3.0 M	67	11.9	9.4	7.5	6.1	5.0	4.2	3.5	
11	11 feet/3.4 M	70	11.9	9.4	7.4	6.0	4.9	4.1	3.4	
12	12 feet/3.7 M	75	11.9	9.3	7.4	5.9	4.8	4.0	3.3	
13	13 feet/4.0 M	78	11.9	9.2	7.3	5.8	4.7	3.9	3.2	
14	14 feet/4.3 M	82	11.8	9.1	7.1	5.7	4.6	3.7	3.1	
15	15 feet/4.6 M	86	11.7	9.0	7.0	5.6	4.5	3.6	3.0	
16	16 feet/4.9 M	90	10.7	8.2	6.3	5.0	4.0	3.2	2.6	
17	17 feet/5.2 M	95	10.4	7.9	6.1	4.8	3.8	3.0	2.4	

Wind speed values are for a 3 second gust per ASCE. Calculated per ANSI C136.20-2012. Assumes load 12 inches above the pole top. Safety factor = 1.5:1. Maximum weight for tenon mount is 100 lbs. Contact factory for AASHTO or specific local codes.