

Job Name: _____	Client Name: _____
Job Location - City: _____ State: _____	Created By: _____ Date: _____
Product: _____ Quote: _____	Customer Approval: _____ Date: _____

SPECIFICATIONS

Transformer Base - The steel fabricated base is a permanent, non-breakaway device. The top and bottom plates are fabricated from structural quality hot rolled carbon steel plate. The casing or shroud separating the top and bottom plates is manufactured from 3 Gauge (0.2391") material. Contact Valmont for loading restrictions.

Access Door - A steel access door and grounding provision is provided. The door opening is 19.50" tall, 8.00" wide at the top, and 10.50" wide at the bottom. A hinged door is available upon request.

Hardware - Connecting bolts, flat washers and hex nuts are provided per base assembly. All structural fasteners are galvanized high strength carbon steel. All non-structural fasteners are galvanized or zinc-plated carbon steel or stainless steel.

Finish - Standard finishes are galvanized, prime painted or any of Valmont's V-PRO™ Protection Systems. Additional finish options available upon request.

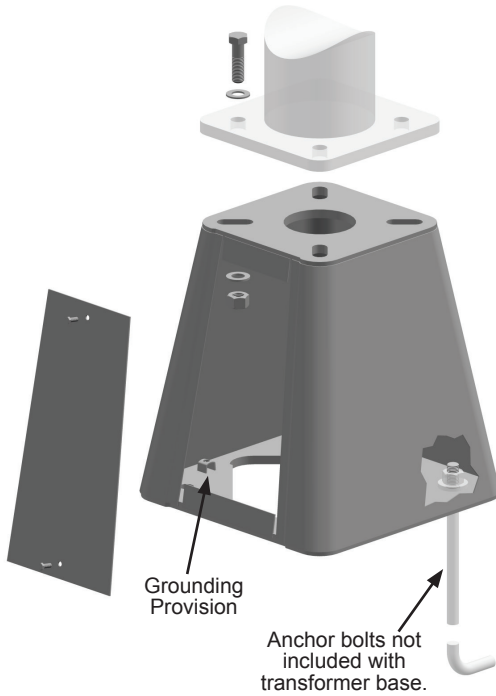

DETAILS

TOP PLATE					BOTTOM PLATE					HEIGHT (IN)	QTY OF ACCESS DOORS	MODEL NUMBER
BOLT CIRCLE		MAX BOLT DIA (IN)	SQUARE (IN)	THK (IN)	BOLT CIRCLE		SQUARE (IN)	THK (IN)				
DIA (IN)	± (IN)				DIA (IN)	± (IN)						
14.00	1.50	1.25	14.81	1.250	22.00	0.00	1.50	21.63	1.250	24.00	1	M223

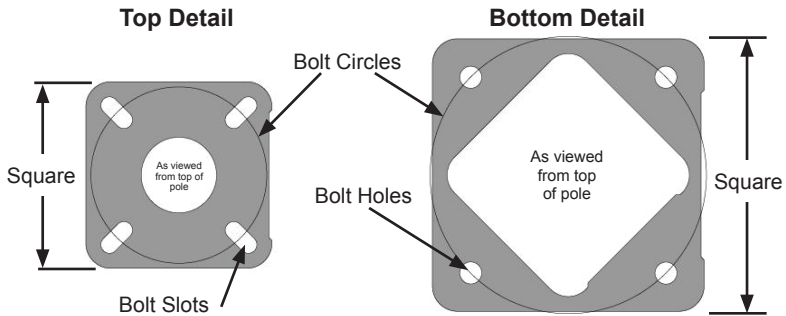

PRODUCT ORDERING CODES

MODEL NUMBER	HARDWARE KIT	FINISH	COLOR	V-PRO PROTECTION SYSTEM	OPTIONS
M223					
Consult factory for available product ordering codes.					

SPC7530 09/15 valmontstructures.com carries the most current spec information and supersedes these guidelines.